

Carlton®

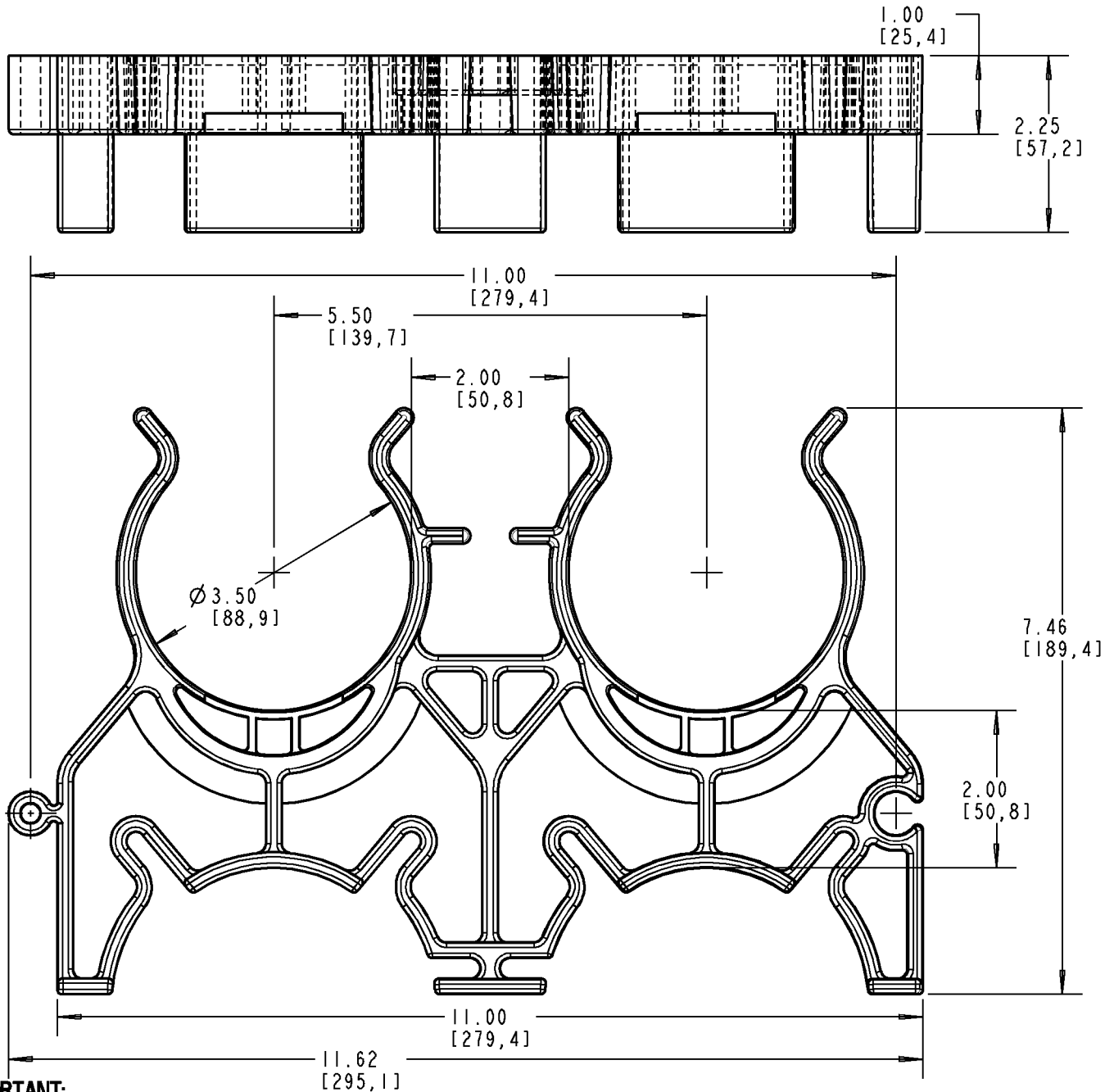

IMPORTANT:

- SNAP-N-STAC™ SPACERS ARE RECOMENDED FOR CONCRETE ENCASED APPLICATIONS ONLY.
- THE USE OF DUCT SPACERS FOR DIRECT BURIAL MAY RESULT IN EXCESSIVE POINT DEFLECTIONS UNLESS PROPER DESIGN ENGINEERING IS APPLIED, SUCH AS THE PROPER COMPACTION OF THE APPROPRIATE BACKFILL MATERIAL.
- CARLTON® IS NOT RESPONSIBLE FOR SNAP-N-STAC™ SPACERS USED IN DIRECT BURY APPLICATIONS.. DESIGN ENGINEERS AND CONTRACTORS ARE RESPONSIBLE FOR THE DESIGN OF THE INSTALLATION.

MATERIAL: HIGH-IMPACT POLYSTYRENE

P/N SP3W20-2

GENERAL NOTES

1. ALL DIMENSIONS ARE FOR REFERENCE ONLY.
2. DIMENSIONS IN BRACKETS [] ARE IN METRIC UNITS.

REVISIONS

B SEE ERN (2012853) FOR APPROVAL SIGNATURES & RELEASE DATE.
PROJECT NO: 5AM000013

Thomas&Betts
www.tnb.com

DESCRIPTION:

SPACER, 3" DUCT X 2" SPACING

ORIGINAL PROJECT NO / (ERN NO)

ND55840 / (2009799)

SHEET NO:

1 OF 2

REV. NO:

B

DRAWING NO:

WSD-AC04692

Carlton®

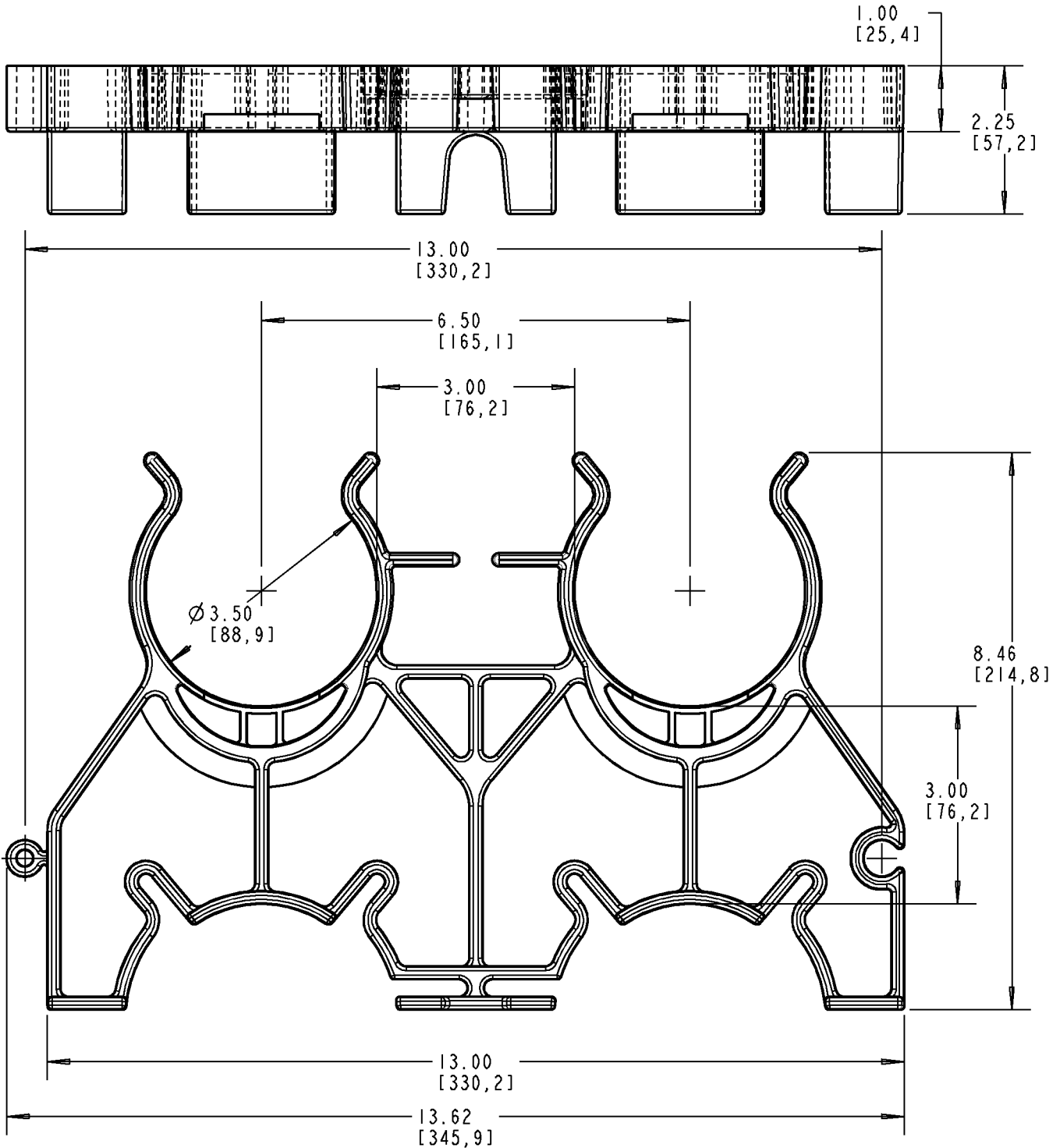

MATERIAL: HIGH-IMPACT POLYSTYRENE

P/N SP3W30-2

GENERAL NOTES

1. ALL DIMENSIONS ARE FOR REFERENCE ONLY.
2. DIMENSIONS IN BRACKETS [] ARE IN METRIC UNITS.

REVISIONS

B SEE ERN (2012853) FOR APPROVAL SIGNATURES & RELEASE DATE.
PROJECT NO: 5AM000013

Thomas & Betts
www.tnb.com

DESCRIPTION:

SPACER, 3" DUCT X 3" SPACING

ORIGINAL PROJECT NO / (ERN NO)

ND55840 / (2009799)

SHEET NO:

2 OF 2

REV. NO:

B

DRAWING NO:

WSD-AC04692